

ASSEMBLY INSTRUCTIONS

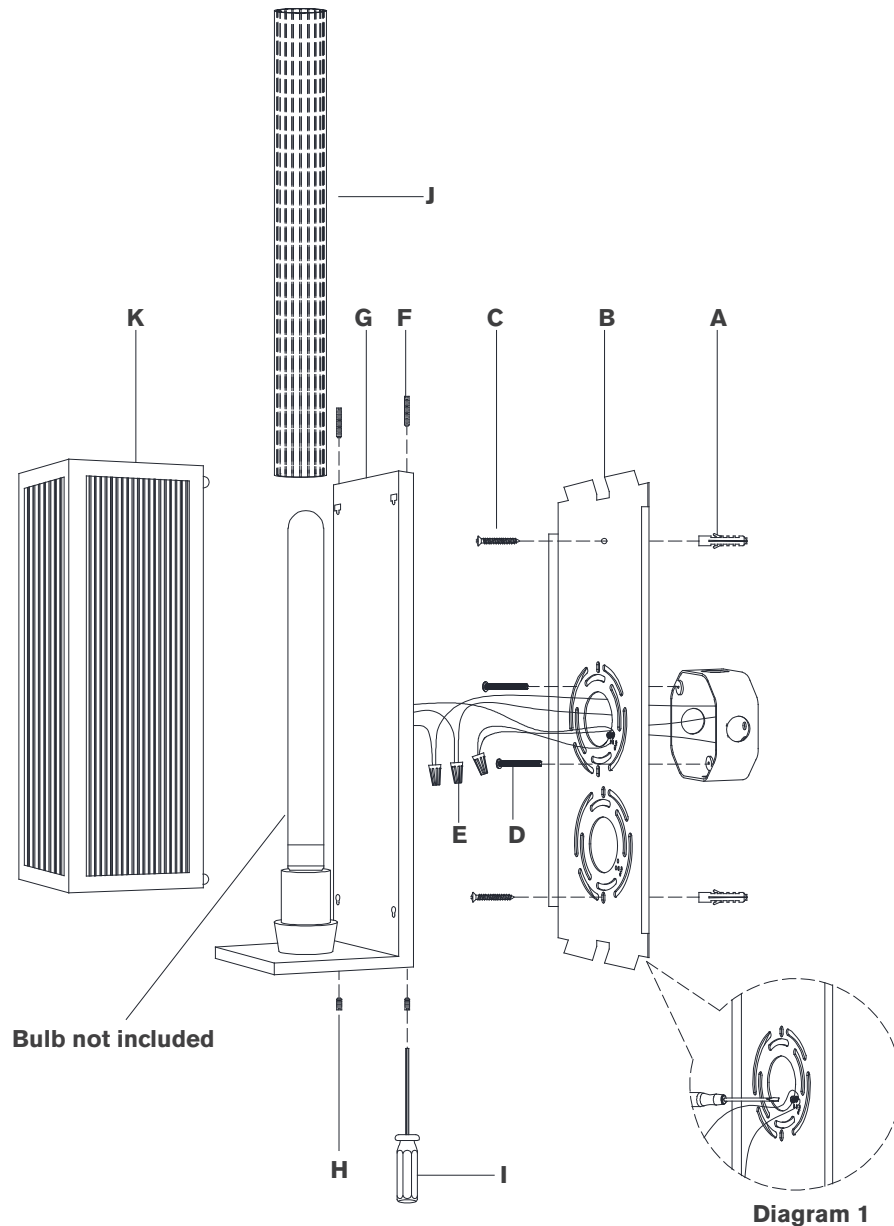

York 16" Single Box Sconce

Item # BBL 2180

NOTICE:

This light fixture should be installed in accordance with all applicable, local installation codes, and by a person familiar with the construction and operation of it, as well as the hazards involved. Inspect item and contents carefully. If any damage or defect is found, do not install. Retain all packaging material until installation is complete and approved.

TOOLS REQUIRED (NOT INCLUDED):

Phillips Screwdriver	Slotted Screwdriver	Drill
Pencil	Hammer	

1. Carefully remove all parts from the box. Place on a clean, soft surface.
2. Remove mounting plate (**B**) from fixture (**G**) by removing set screws (**F & H**) using provided screwdriver (**I**).
3. Using mounting plate (**B**) as a guide, line up with the junction box and mark anchor positions.
4. Using a drill bit slightly smaller than the anchor, drill holes in the marked positions. Install anchors (**A**) into the holes using hammer.
5. Install mounting plate (**B**) to the junction box and secure with mounting screws (**D**), then secure wood screws (**C**) to anchors (**A**).
6. Wrap fixture ground wire (bare copper) around the green grounding screw (see diagram 1). Tighten. Continue fixture ground wire and connect to supply ground wire (usually green or bare copper) using wire nut (**E**).

NOTE: It is imperative that the fixture is grounded.

7. Connect fixture neutral wire (white) to the supply neutral wire (usually white) using wire nut (**E**).
8. Connect fixture hot wire (black) to the supply hot wire (usually black) using wire nut (**E**).

CAUTION: Do not reverse the hot and neutral connections.

9. Make sure all wire connections are tight, then carefully tuck into the junction box.

ASSEMBLY INSTRUCTIONS

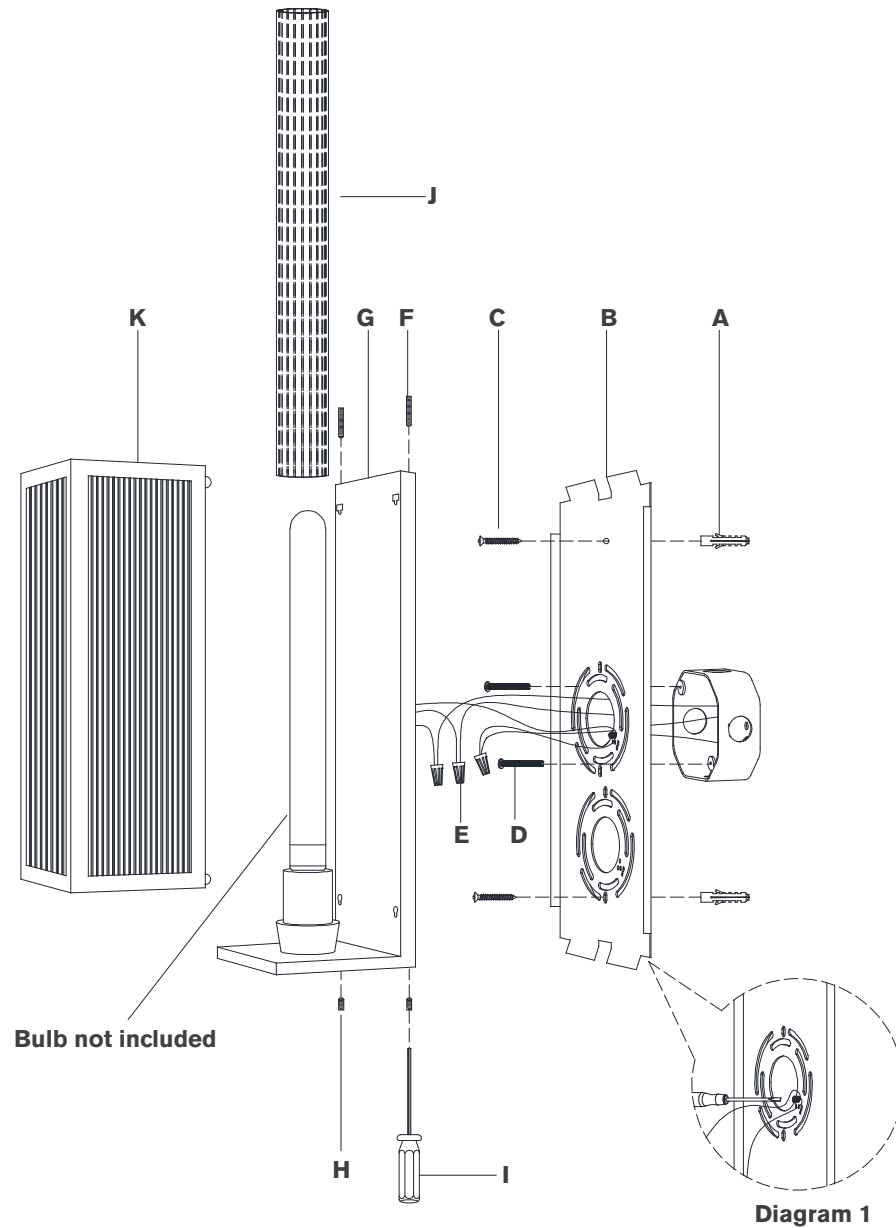

York 16" Single Box Sconce

Item # BBL 2180

NOTICE:

This light fixture should be installed in accordance with all applicable, local installation codes, and by a person familiar with the construction and operation of it, as well as the hazards involved. Inspect item and contents carefully. If any damage or defect is found, do not install. Retain all packaging material until installation is complete and approved.

10. Install fixture (**G**) to mounting plate (**B**) and secure with set screws (**F & H**) using provided screwdriver (**I**).
11. Install light bulb into the socket.

FOR DAMP LOCATION INSTALLATION:

12. Hang shade (**K**) to fixture body (**G**) by aligning hangers of shade to keyed slots on backplates, then slide down to secure.

FOR OUTDOOR/WET LOCATION INSTALLATION:

12. Place glass tube (**J**) over light bulb and rest on socket base.
13. Hang shade (**K**) to fixture body (**G**) by aligning hangers of shade to keyed slots on backplates, then slide down to secure.
14. Using silicon compound, apply a small bead where backplate meets the wall to prevent water from entering.

NOTE: Large gaps will need to be corrected before applying silicon compound.

Care Instructions: Clean only with a soft dry cloth or feather duster. Do not use abrasive or chemical agents.